

Forced convection unit air cooler - flatline

FHVT 614

Place of cooling:

Walter Roller GmbH & Co.
Lindenstraße 27-31
D - 70839 Gerlingen
Phone: +49 (0)7156 2001 - 0
Fax.: +49 (0)7156 2001 26



Version 5.5.2
18.11.2004

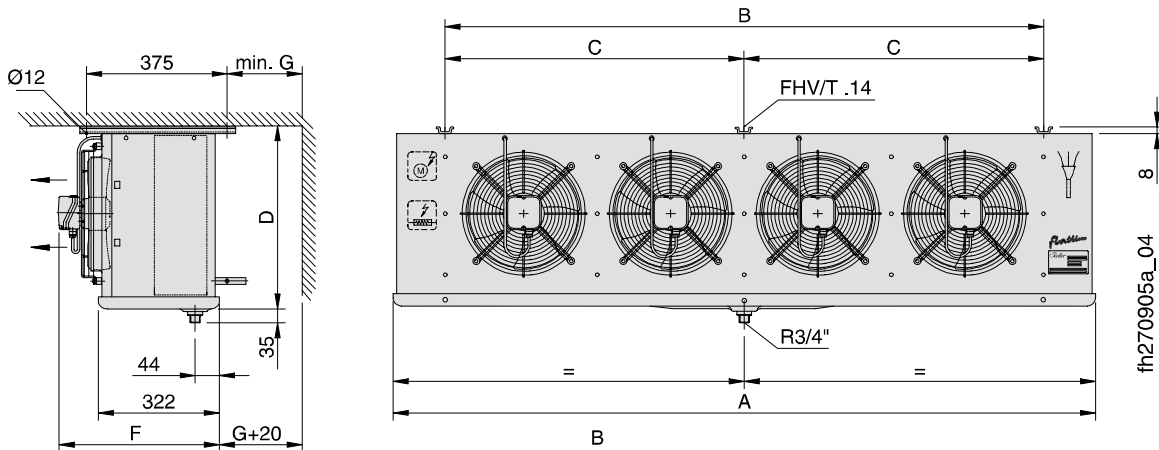

Dimensions, Tube volumes, Weights

Dimensions								Tube vol. [dm³]	Weight [kg]	Connections	
A [mm]	B [mm]	C [mm]	D [mm]	E [mm]	F [mm]	G [mm]	H [mm]			Inlet Ø [mm]	Outlet Ø [mm]
1878	1596	798	460		430	250		8.20	56	15.0 #	28.0

#: Multiple injection with Schrader valve at the outlet

Electrical loads

No.	Blade ø [mm]	Power supply [V, Hz]	Input capacity [W]	Current [A]	No. of re- volutions [min⁻¹]	Electric defrost heating			El. aircondition	
						Coil [W]	Drip [W]	Total [W]	[W]	Total [W]
4	300 S	~230 V 50/60 Hz	80/112	0,36/0,48	1340/1460	3x1310	1x1310	5240		

Capacity data

	Refrigerant	Capacity P _e [kW]	Evapora- tion t _e [°C]	Air inlet t _{A1} [°C]	DT1 [K]	Sur- face [m²]	Air capacity [m³/h]	Air throw [m]	Sound power [dB(A)]	Fin spacing [mm]
Result	R404A	6.29	-6.0	0.0	6.0	27.6	6240	11	74	6.0

Prices and accessories

FHVT 614	

Price per unit:

inkl. mat. surcharges, without VAT